

| |
|-----------|
| PROJECT |
| TYPE |
| SPECIFIER |
| QUANTITY |
| DATE |

FLAMINGO POST

E9B153-

base number Finish
Options

- To build a product code in our configurator select the specify button on the base model # product page
- To build a manual product code on this datasheet choose from the options listed below in blue font and add the suffix to the base model #

GENERAL

Series: Flamingo
 Brand: Platek
 Division: Exterior
 Mounting Type: Post
 Mounting Location: Above Ground
 Subcategory: Bollard - Garden

PHYSICAL

Shape: Abstract
 Diameter (mm): 55
 Diameter (in): 2 ³/₁₆
 Height (mm): 800
 Height (in): 31 ¹/₂
 Extension (mm): 450
 Extension (in): 17 ¹¹/₁₆
 Light Distribution: Direct
 Weight (kg): 1.4
 Weight (lbs): 3
 Screws: No visible screws
 Diffuser: Frosted Methacrylate - 2mm
 Fixture Finish: [BLK / WHI / COR](#)
 Fixture Material: Aluminum
 Upon Request: Finishes - Anthracite, Bronze

ELECTRICAL

Lamp Type: LED
 Input Wattage (W): 9
 Total Output Wattage (W): 7
 Dimming: Non-Dimmable / 0-10V Dimming
 Driver Included: No
 Driver Location: Remote
 Driver Type: Constant Voltage - Universal
 Driver Class: Class 2
 Housing: ENCP5
 Input Voltage (V): 120 - 277
 Constant Voltage (V): 24

LED

Number of LEDs: 1
 Color Temperature (°K): 3000
 Max. Delivered Lumen (lm): 385
 Nominal Lumen (lm): 705
 CRI: >80 CRI
 Lamp Life (hrs): 60000

OPTICAL

Optic°: 76
 Beam Angle: Diffused

RATINGS AND CERTIFICATIONS

Certified By: Certified for North American Standards
 IP rating: IP65
 IK Rating: IK06
 Bug Rating: B0 U0 G0
 Upon Request: Higher Maximum Ambient Temperature



FLAMINGO POST

E9B153-

PROJECT

TYPE

SPECIFIER

QUANTITY

DATE



E

| |
|-----------|
| PROJECT |
| TYPE |
| SPECIFIER |
| QUANTITY |
| DATE |

FLAMINGO POST

E9B155-

base number Finish
Options

- To build a product code in our configurator select the specify button on the base model # product page
- To build a manual product code on this datasheet choose from the options listed below in blue font and add the suffix to the base model #

GENERAL

Series: Flamingo
 Brand: Platek
 Division: Exterior
 Mounting Type: Post
 Mounting Location: Above Ground
 Subcategory: Bollard

PHYSICAL

Shape: Abstract
 Diameter (mm): 55
 Diameter (in): 2 3/16
 Height (mm): 1500
 Height (in): 59 1/16
 Extension (mm): 450
 Extension (in): 17 11/16
 Light Distribution: Direct
 Weight (kg): 1.8
 Weight (lbs): 4
 Screws: No visible screws
 Diffuser: Frosted Methacrylate - 2mm
 Fixture Finish: [BLK / WHI / COR](#)
 Fixture Material: Aluminum
 Upon Request: Finishes - Anthracite, Bronze

ELECTRICAL

Lamp Type: LED
 Input Wattage (W): 9
 Total Output Wattage (W): 7
 Dimming: Non-Dimmable / 0-10V Dimming
 Driver Included: No
 Driver Location: Remote
 Driver Type: Constant Voltage - Universal
 Driver Class: Class 2
 Input Voltage (V): 120 - 277
 Constant Voltage (V): 24

LED

Number of LEDs: 1
 Color Temperature (°K): 3000
 Max. Delivered Lumen (lm): 385
 Nominal Lumen (lm): 705
 CRI: >80 CRI
 Lamp Life (hrs): 60000

OPTICAL

Optic°: 76
 Beam Angle: Diffused

RATINGS AND CERTIFICATIONS

Certified By: Certified for North American Standards
 IP rating: IP65
 IK Rating: IK06
 Bug Rating: B0 U0 G0
 Upon Request: Higher Maximum Ambient Temperature



FLAMINGO POST

E9B155-

| | |
|-----------|-------|
| PROJECT | _____ |
| TYPE | _____ |
| SPECIFIER | _____ |
| QUANTITY | _____ |
| DATE | _____ |

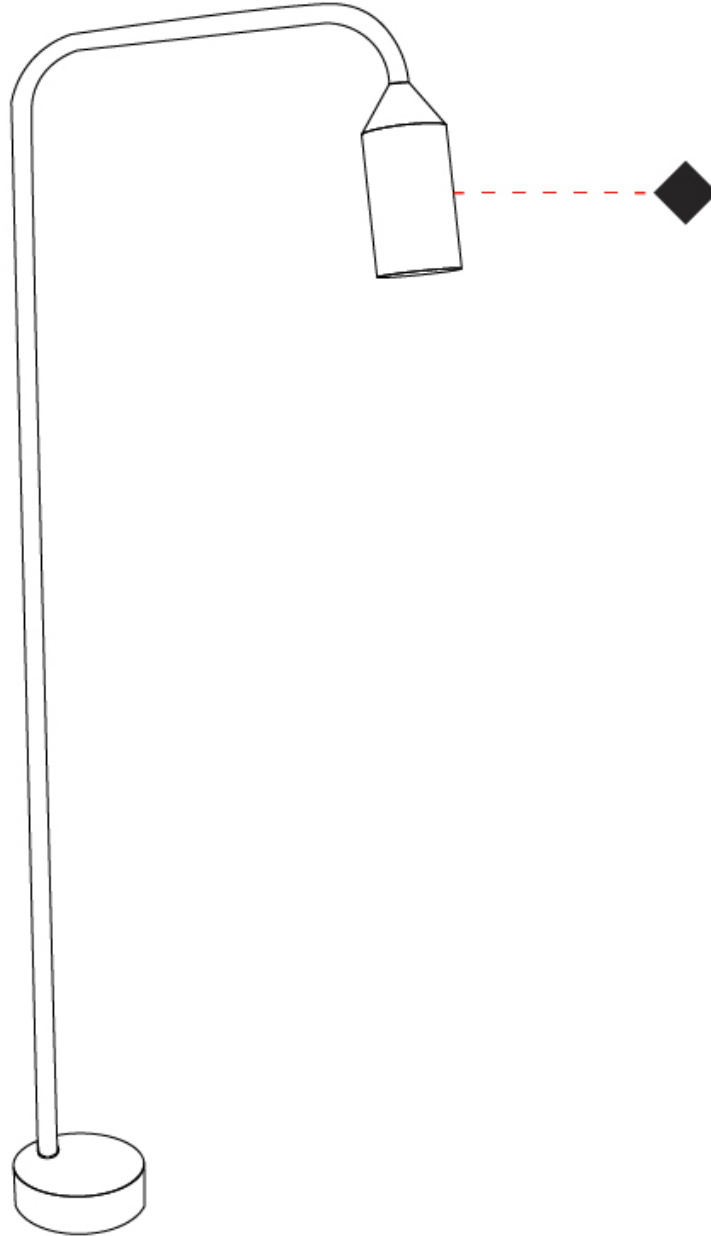

E

FLAMINGO POST

E9B157-

base number Finish
 Options

- To build a product code in our configurator select the specify button on the base model # product page
- To build a manual product code on this datasheet choose from the options listed below in blue font and add the suffix to the base model #

GENERAL

Series: Flamingo
 Brand: Platek
 Division: Exterior
 Mounting Type: Post
 Mounting Location: Above Ground
 Subcategory: Bollard

PHYSICAL

Shape: Abstract
 Diameter (mm): 55
 Diameter (in): 2 3/16
 Height (mm): 1900
 Height (in): 74 13/16
 Extension (mm): 450
 Extension (in): 17 11/16
 Light Distribution: Direct
 Weight (kg): 2
 Weight (lbs): 4.4
 Screws: No visible screws
 Diffuser: Frosted Methacrylate - 2mm
 Fixture Finish: [BLK / WHI / COR](#)
 Fixture Material: Aluminum
 Upon Request: Finishes - Anthracite, Bronze

ELECTRICAL

Lamp Type: LED
 Input Wattage (W): 9
 Total Output Wattage (W): 7
 Dimming: Non-Dimmable / 0-10V Dimming
 Driver Included: No
 Driver Location: Remote
 Driver Type: Constant Voltage - Universal
 Driver Class: Class 2
 Input Voltage (V): 120 - 277
 Constant Voltage (V): 24

LED

Number of LEDs: 1
 Color Temperature (°K): 3000
 Max. Delivered Lumen (lm): 385
 Nominal Lumen (lm): 705
 CRI: >80 CRI
 Lamp Life (hrs): 60000

OPTICAL

Optic°: 76
 Beam Angle: Diffused

RATINGS AND CERTIFICATIONS

Certified By: Certified for North American Standards
 IP rating: IP65
 IK Rating: IK06
 Bug Rating: B0 U0 G0
 Upon Request: Higher Maximum Ambient Temperature



FLAMINGO POST

E9B157-

PROJECT

TYPE

SPECIFIER

QUANTITY

DATE



E

FLAMINGO SURFACE

E9C092-

base number Finish
 Options

- To build a product code in our configurator select the specify button on the base model # product page
- To build a manual product code on this datasheet choose from the options listed below in blue font and add the suffix to the base model #

GENERAL

Series: Flamingo
 Brand: Platek
 Division: Exterior
 Mounting Type: Surface
 Mounting Location: Ceiling
 Subcategory: Downlight

PHYSICAL

Shape: Abstract
 Diameter (mm): 55
 Diameter (in): 2 ³/₁₆
 Height (mm): 170
 Height (in): 6 ¹¹/₁₆
 Extension (mm): 450
 Extension (in): 17 ¹¹/₁₆
 Light Distribution: Direct
 Weight (kg): 0.6
 Weight (lbs): 1.3
 Screws: No visible screws
 Diffuser: Frosted Methacrylate - 2mm
 Fixture Finish: [BLK / WHI / COR](#)
 Fixture Material: Aluminum
 Upon Request: Finishes - Anthracite, Bronze

ELECTRICAL

Lamp Type: LED
 Input Wattage (W): 9
 Total Output Wattage (W): 7
 Dimming: Non-Dimmable / 0-10V Dimming
 Driver Included: No
 Driver Location: Remote
 Driver Type: Constant Voltage - Universal
 Driver Class: Class 2
 Input Voltage (V): 120 - 277
 Constant Voltage (V): 24

LED

Number of LEDs: 1
 Color Temperature (°K): 3000
 Max. Delivered Lumen (lm): 385
 Nominal Lumen (lm): 705
 CRI: >80 CRI
 Lamp Life (hrs): 60000

OPTICAL

Optic°: 76
 Beam Angle: Diffused

RATINGS AND CERTIFICATIONS

Certified By: Certified for North American Standards
 IP rating: IP65
 IK Rating: IK06
 Bug Rating: B0 U0 G0
 Upon Request: Higher Maximum Ambient Temperature



E9C092-

PROJECT

TYPE

SPECIFIER

QUANTITY

DATE



FLAMINGO SUSPENSION

E9C094-

base number Finish
 Options

- To build a product code in our configurator select the specify button on the base model # product page
- To build a manual product code on this datasheet choose from the options listed below in blue font and add the suffix to the base model #

GENERAL

Series: Flamingo
 Brand: Platek
 Division: Exterior
 Mounting Type: Suspension
 Mounting Location: Ceiling
 Subcategory: Downlight

PHYSICAL

Shape: Cylinder
 Diameter (mm): 55
 Diameter (in): 2 3/16
 Height (mm): 800
 Height (in): 31 1/2
 Extension (mm): 450
 Extension (in): 17 11/16
 Light Distribution: Direct
 Weight (kg): 1
 Weight (lbs): 2.2
 Screws: No visible screws
 Diffuser: Frosted Methacrylate - 2mm
 Fixture Finish: [BLK / WHI / COR](#)
 Fixture Material: Aluminum
 Upon Request: Finishes - Anthracite, Bronze

ELECTRICAL

Lamp Type: LED
 Input Wattage (W): 9
 Total Output Wattage (W): 7
 Dimming: Non-Dimmable / 0-10V Dimming
 Driver Included: No
 Driver Location: Remote
 Driver Type: Constant Voltage - Universal
 Driver Class: Class 2
 Input Voltage (V): 120 - 277
 Constant Voltage (V): 24

LED

Number of LEDs: 1
 Color Temperature (°K): 3000
 Max. Delivered Lumen (lm): 385
 Nominal Lumen (lm): 705
 CRI: >80 CRI
 Lamp Life (hrs): 60000

OPTICAL

Optic°: 76
 Beam Angle: Diffused

RATINGS AND CERTIFICATIONS

Certified By: Certified for North American Standards
 IP rating: IP65
 IK Rating: IK06
 Bug Rating: B0 U0 G0
 Upon Request: Higher Maximum Ambient Temperature



FLAMINGO SUSPENSION

E9C094-

PROJECT _____

TYPE _____

SPECIFIER _____

QUANTITY _____

DATE _____

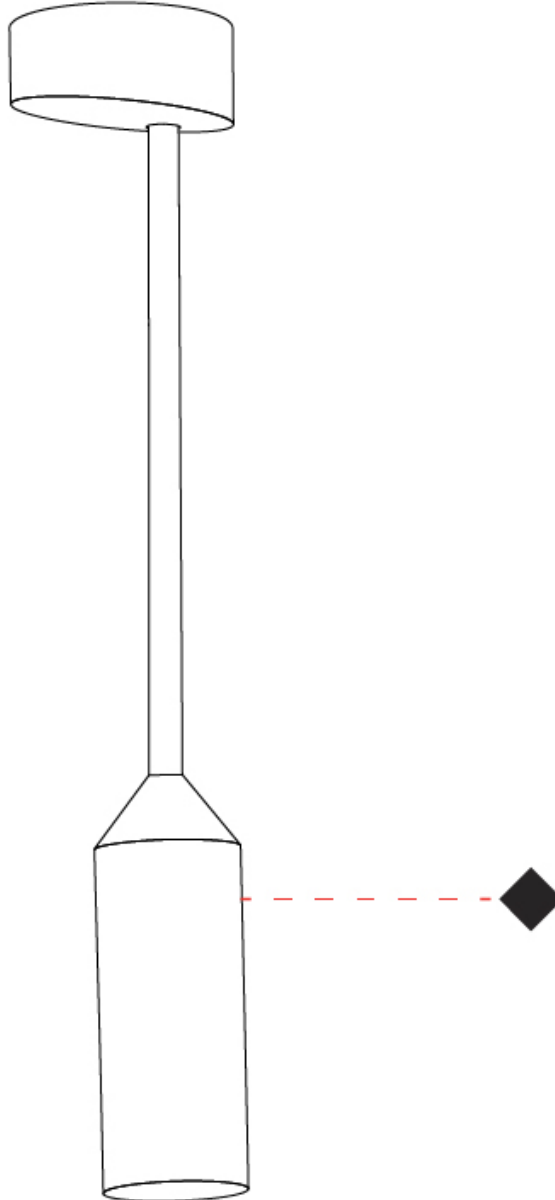

E

| |
|-----------|
| PROJECT |
| TYPE |
| SPECIFIER |
| QUANTITY |
| DATE |

FLAMINGO SURFACE

E9W500-

base number Finish
Options

- To build a product code in our configurator select the specify button on the base model # product page
- To build a manual product code on this datasheet choose from the options listed below in blue font and add the suffix to the base model #

GENERAL

Series: Flamingo
 Brand: Platek
 Division: Exterior
 Mounting Type: Surface
 Mounting Location: Wall
 Subcategory: Downlight

PHYSICAL

Shape: Abstract
 Diameter (mm): 55
 Diameter (in): 2 3/16
 Height (mm): 800
 Height (in): 31 1/2
 Extension (mm): 370
 Extension (in): 14 9/16
 Light Distribution: Direct
 Weight (kg): 1
 Weight (lbs): 2.2
 Screws: No visible screws
 Diffuser: Frosted Methacrylate - 2mm
 Fixture Finish: [BLK / WHI / COR](#)
 Fixture Material: Aluminum
 Upon Request: Finishes - Anthracite, Bronze

ELECTRICAL

Lamp Type: LED
 Input Wattage (W): 9
 Total Output Wattage (W): 7.5
 Dimming: Non-Dimmable / 0-10V Dimming
 Driver Included: No
 Driver Location: Remote
 Driver Type: Constant Voltage - Universal
 Driver Class: Class 2
 Input Voltage (V): 120 - 277
 Constant Voltage (V): 24

LED

Number of LEDs: 1
 Color Temperature (°K): 3000
 Max. Delivered Lumen (lm): 385
 Nominal Lumen (lm): 705
 CRI: >80 CRI
 Lamp Life (hrs): 60000

OPTICAL

Optic°: 76
 Beam Angle: Diffused

RATINGS AND CERTIFICATIONS

Certified By: Certified for North American Standards
 IP rating: IP65
 IK Rating: IK06
 Bug Rating: B0 U0 G0
 Upon Request: Higher Maximum Ambient Temperature



E9W500-

PROJECT _____

TYPE _____

SPECIFIER _____

QUANTITY _____

DATE _____

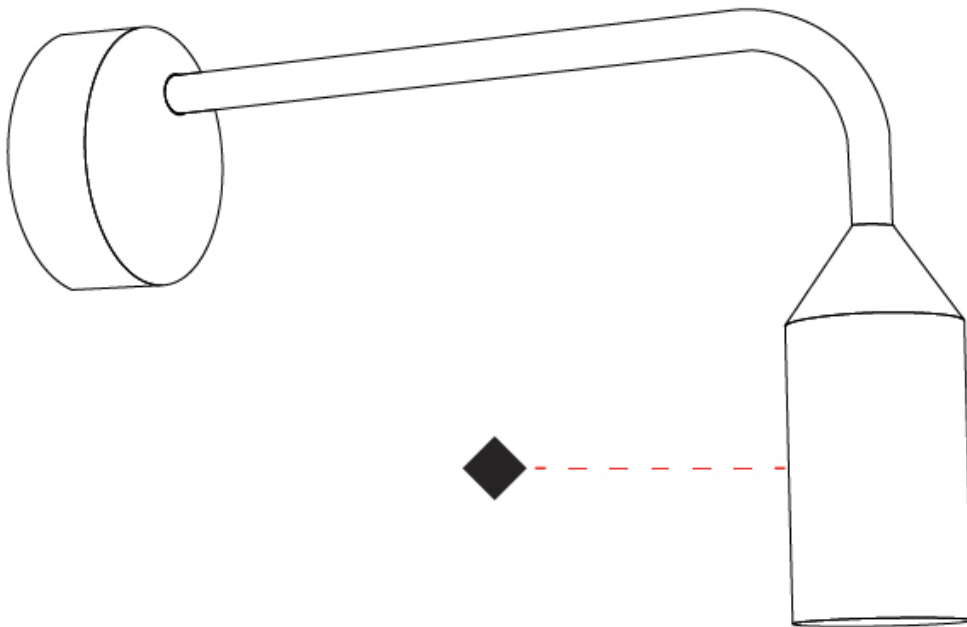

E

| |
|-----------|
| PROJECT |
| TYPE |
| SPECIFIER |
| QUANTITY |
| DATE |

FLAMINGO SURFACE

E9W502-

base number Finish
Options

- To build a product code in our configurator select the specify button on the base model # product page
- To build a manual product code on this datasheet choose from the options listed below in blue font and add the suffix to the base model #

GENERAL

Series: Flamingo
 Brand: Platek
 Division: Exterior
 Mounting Type: Surface
 Mounting Location: Wall
 Subcategory: Downlight

PHYSICAL

Shape: Abstract
 Diameter (mm): 55
 Diameter (in): 2 3/16
 Height (mm): 850
 Height (in): 33 7/16
 Extension (mm): 1400
 Extension (in): 55 1/8
 Light Distribution: Direct
 Weight (kg): 5
 Weight (lbs): 11
 Installation Requirement: Waterproof J-Box is included
 Screws: No visible screws
 Diffuser: Frosted Methacrylate - 2mm
 Fixture Finish: [BLK](#) / [WHI](#) / [COR](#)
 Fixture Material: Aluminum
 Upon Request: Finishes - Anthracite, Bronze

ELECTRICAL

Lamp Type: LED
 Input Wattage (W): 9
 Total Output Wattage (W): 7.5
 Dimming: Non-Dimmable / 0-10V Dimming
 Driver Included: No
 Driver Location: Remote
 Driver Type: Constant Voltage - Universal
 Driver Class: Class 2
 Housing: ENCP5
 Input Voltage (V): 120 - 277
 Constant Voltage (V): 24

LED

Number of LEDs: 1
 Color Temperature (°K): 3000
 Max. Delivered Lumen (lm): 385
 Nominal Lumen (lm): 705
 CRI: >80 CRI
 Lamp Life (hrs): 60000

OPTICAL

Optic°: 76
 Beam Angle: Diffused

RATINGS AND CERTIFICATIONS

Certified By: Certified for North American Standards
 IP rating: IP65
 IK Rating: IK06
 Bug Rating: B0 U0 G0
 Upon Request: Higher Maximum Ambient Temperature

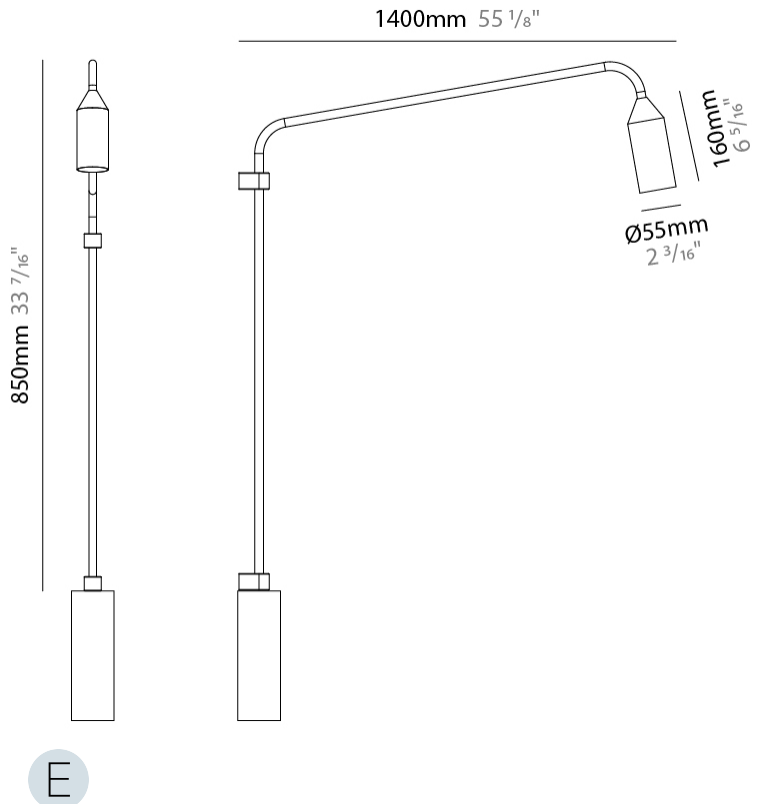

E9W502-

PROJECT

TYPE

SPECIFIER

QUANTITY

DATE



E

FLAMINGO SURFACE

E9W504-

base number Finish
Options

- To build a product code in our configurator select the specify button on the base model # product page
- To build a manual product code on this datasheet choose from the options listed below in blue font and add the suffix to the base model #

GENERAL

Series: Flamingo
Brand: Platek
Division: Exterior
Mounting Type: Surface
Mounting Location: Wall
Subcategory: Downlight

PHYSICAL

Shape: Abstract
Diameter (mm): 55
Diameter (in): 2 3/16
Height (mm): 2200
Height (in): 86 5/8
Extension (mm): 1400
Extension (in): 55 1/8
Light Distribution: Direct
Weight (kg): 5.8
Weight (lbs): 12.8
Installation Requirement: Waterproof J-Box is included
Screws: No visible screws
Diffuser: Frosted Methacrylate - 2mm
Fixture Finish: BLK / WHI / COR
Fixture Material: Aluminum
Upon Request: Finishes - Anthracite, Bronze

ELECTRICAL

Lamp Type: LED
Input Wattage (W): 9
Total Output Wattage (W): 7.5
Dimming: Non-Dimmable / 0-10V Dimming
Driver Included: No
Driver Location: Remote
Driver Type: Constant Voltage - Universal
Driver Class: Class 2
Input Voltage (V): 120 - 277
Constant Voltage (V): 24

LED

Number of LEDs: 1
Color Temperature (°K): 3000
Max. Delivered Lumen (lm): 385
Nominal Lumen (lm): 705
CRI: >80 CRI
Lamp Life (hrs): 60000

OPTICAL

Optic°: 76
Beam Angle: Diffused

RATINGS AND CERTIFICATIONS

Certified By: Certified for North American Standards
IP rating: IP65
IK Rating: IK06
Bug Rating: B0 U0 G0
Upon Request: Higher Maximum Ambient Temperature

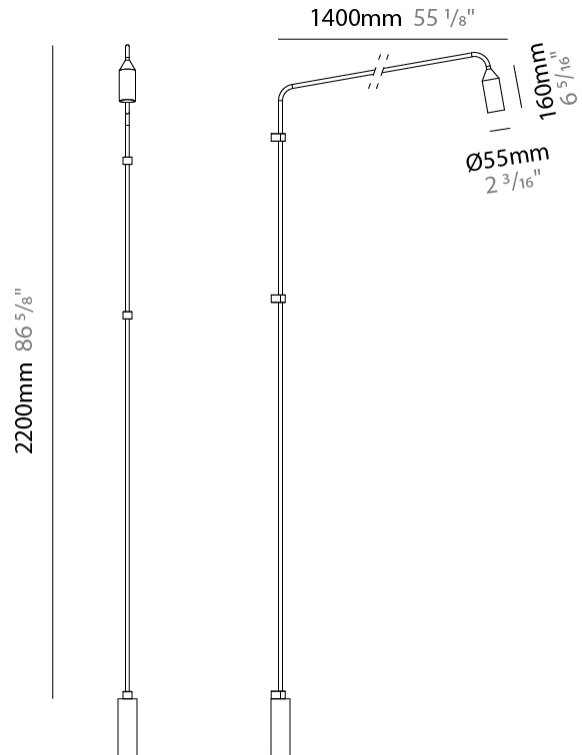
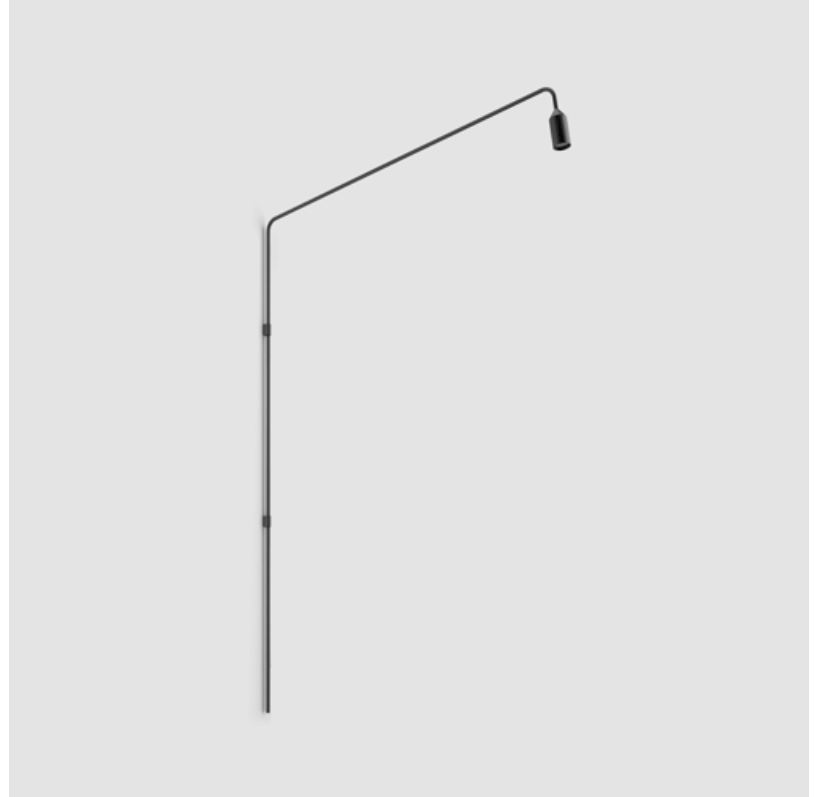

E9W504-

PROJECT

TYPE

SPECIFIER

QUANTITY

DATE



E

FLAMINGO COLOR FINISH CHART

| | |
|-----------|-------|
| PROJECT | _____ |
| TYPE | _____ |
| SPECIFIER | _____ |
| QUANTITY | _____ |
| DATE | _____ |

Fixture Finish

Black - BLK



White - WHI

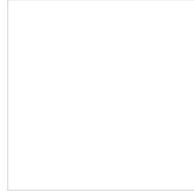

Corten - COR



Digital: Not all screens are calibrated the same, and therefore, colors will appear differently between screens.

Physical: When texture is involved, there will be variations in color, character and tone within a product series and between product families.



| | |
|-----------|--|
| PROJECT | |
| TYPE | |
| SPECIFIER | |
| QUANTITY | |
| DATE | |

LEGEND

| | | |
|---|--|--|
| floor-mounted | pivotal | special LED (upon request) RGB, RGBW, tunable, gold+, meat+, art+, fashion+ |
| wall and ceiling: recessed and surface mounted | rotating | warm dim / natural dimming LED |
| ceiling-mounted and wall-mounted | illuminate tilted | rechargeable battery powered |
| wall-mounted | color of suspension cable | fixture with natural vivid LED (upon request) |
| omni-directional light distribution | length of suspension cable | color rendering index |
| direct light distribution | reflector degree selection | color temperature |
| direct/indirect light distribution | super spot | lumen (luminous flux) |
| indirect light distribution | lens | efficacy (lumens per watt) |
| asymmetric light distribution | lens pack | Unified Glare Rating (UGR) range from 5-40 |
| aura light distribution | shine ring | marine grade (AISI 316 stainless steel) |
| round wall or ceiling cut-out | integrated shine ring with diffuser | walk on |
| square wall or ceiling cut-out | free individual colors 01-29 | drive on |
| the supplied jig specifies the cutout dimensions | individual colors: 00 (free of charge), 01-25 (extra charge) | Dark Sky Compliance |
| minimum distance (meters) lamp - object | luminaire part to be colored (F1) | Americans with Disabilities Act (less than 4" off the wall located between 27"-84" from floor) |
| recessed depth | luminaire part to be colored (F2) | lamp protected against explosion |
| ceiling thickness in mm | luminaire part to be colored (F3) | blown glass using traditional methods by master glass blower |
| ceiling thickness selection | luminaire part to be colored (F4) | acoustic material |
| dimmable DP (phase), DV (0-10V), DD (dali), DS (step-dim) | luminaire part to be colored (F5) | protection class I, protection insulation |
| included or excluded LED driver/transformer/control gear | color of 3-circuit adaptor | protection class II, protection insulation |
| separately switchable | indirect diffuser | ETL Certified to UL and CSA Standards |
| sensor | direct diffuser | UL Certified to UL and CSA Standards |
| remote control | ball-proof (upon request) | CSA Certified to UL and CSA Standards |
| available upon request | accessory | Certified for North American Standards |

IP RATING

| | |
|------|--|
| IP20 | protected against ingress of solid bodies greater than 12.5mm (finger) |
| IP33 | protected against ingress of solid bodies greater than 2.5mm protected against sprays of water up to 60 degrees from the vertical (rain) |
| IP40 | protected against ingress of solid bodies greater than 1mm (wire) no protection against the ingress of moisture |
| IP43 | protected against ingress of solid bodies greater than 1mm (wire) protected against sprays of water up to 60 degrees from the vertical (rain) |
| IP44 | protected against ingress of solid bodies greater than 1mm (wire) protected against water splashed from all directions |
| IP54 | protected against limited ingress of dust (wet rooms/covered outdoor areas) protected against water splashed from all directions |
| IP65 | protected against ingress of dust protected against jets of water |
| IP66 | protected against ingress of dust protected against powerful jets of water or heavy seas |
| IP67 | protected against ingress of dust protected against immersion of water between 15cm - 1m for 30 minutes |
| IP68 | protected against ingress of dust protected against immersion of water under pressure for long periods |

IK RATING

| | |
|------|---|
| IK01 | protected against 0.14 joules impact (equivalent to 0.25kg mass dropped from 56mm above the surface) |
| IK02 | protected against 0.2 joules impact (equivalent to 0.25kg mass dropped from 80mm above the surface) |
| IK03 | protected against 0.35 joules impact (equivalent to 0.25kg mass dropped from 140mm above the surface) |
| IK04 | protected against 0.5 joules impact (equivalent to 0.25kg mass dropped from 200mm above the surface) |
| IK05 | protected against 0.7 joules impact (equivalent to 0.25kg mass dropped from 280mm above the surface) |
| IK06 | protected against 1 joules impact (equivalent to 0.25kg mass dropped from 400mm above the surface) |
| IK07 | protected against 2 joules impact (equivalent to 0.5kg mass dropped from 400mm above the surface) |
| IK08 | protected against 5 joules impact (equivalent to 1.7kg mass dropped from 300mm above the surface) |
| IK09 | protected against 10 joules impact (equivalent to 5.0kg mass dropped from 200mm above the surface) |
| IK10 | protected against 20 joules impact (equivalent to 5.0kg mass dropped from 400mm above the surface) |